

Pole Attachment Policy

LAST UPDATED 8.19.2024



AMERICAN ELECTRIC POWER
AEP TEXAS
POLE ATTACHMENT POLICY

Table of Contents

INTRODUCTION 3

Definitions 3

PROCESS/PROCEDURE 6

Application/Approval Process For Joint Use Pole Attachments..... 6

Application..... 7

Response..... 8

Installation and Maintenance..... 9

Completion of the Attachment..... 9

Post Construction Inspection 9

GENERAL DESIGN AND CONSTRUCTION GUIDELINES..... 10

Structure of the Distribution Pole and Working Zones..... 10

Design 10

Construction 12

Wireless Attachment Standard..... 12

Removal and Abandonment 16

Communication Attachments on Distribution Pole with Streetlight 16

Identification Guidelines / Tagging Requirements 17

Safety 17

Safety Regulations and Requirements 18

Emergency Situations..... 18

Pole Warning Markers 18

Pole Treatment..... 19

Duty to Inspect 19

AEP TEXAS Standards and Specifications 19

CONTACT INFORMATION 19

AEP TEXAS Contacts 19

Selection of Qualified Contractors..... 20

Approved Engineering Contractors..... 20

Approved Contractors to Work in the Supply Space 20



AEP TEXAS
AEP TEXAS

Appendix	21
Appendix 1 - Cable Clearance	21
Appendix 2– Ground Wire Installation	22
Appendix 3 – Conduit Stand-off Bracket	23
Appendix 4 – Equipment Location	24
Appendix 5 – Climbing Space	25
Appendix 6 – Temporary Sign/Banner	26
Appendix 7 – Clearance for Lighting Facilities	27
Appendix 8 – Clearances for Telecommunications Equipment	28
Appendix 9 – Guy Wires	29
Appendix 10 – Parallel Span Guys	30
Appendix 11 – Transverse Span Guys	31
Appendix 12 – Pole Numbering and Tagging	32
Appendix 13 – Examples of Advisory Tags	33



INTRODUCTION

This document is intended to assist pole attachment requestors in AEP Texas with establishing a pole attachment agreement, requesting attachment rights, and ensuring that poles are safe for the addition of those attachments, both before and after communication cables/equipment are placed. Texas is regulated by the Federal Communications Commission, and this procedure adheres to the Pole Attachment Act, 47 U.S.C. § 224, and applicable decisions, orders or regulations interpreting or implementing the Pole Attachment Act, including, but not limited to, those promulgated by the Federal Communications Commission (FCC). AEP Texas shall enforce the processes and procedures outlined in this document to expedite attachment requests and to ensure that all parties seeking to attach to AEP Texas facilities are treated in a fair, reasonable, and consistent manner. Should there be any discrepancy between this document and a fully executed Pole Attachment Agreement, the Pole Attachment Agreement will take precedent.

Definitions

Ancillary Equipment – Auxiliary or accessory equipment associated with either power or communication devices, e.g. control box, power converter.

Attacher – A provider of cable television services and/or Telecommunications Service to which AEP Texas granted certain non-exclusive rights to use its Poles, pursuant to 47 U.S.C. § 224, and which has entered into, and maintains in force and effect, a Pole Attachment Agreement with AEP Texas.

Attachment – Any fiber optic cable, coaxial cable, or the cable and wires connected to such fiber optic cable or coaxial cable, and all supporting cable used (i) by a cable television system operator to provide only cable television services; or (ii) by a Telecommunications Carrier to provide Telecommunications Service, as such terms are defined in Section 153 of the Communication Act; or (iii) the physical attachment of such facilities and equipment to any Pole. For purposes of the Antenna Guidelines, the term “Attachment” does not include equipment used exclusively to provide broadband transmission, or broadband Internet access service.

Communications Act – Communications Act of 1934, as amended by the Telecommunications Act of 1996.

Communication Space - The space of joint-use structures where communication facilities are separated from the Supply Space by the Communication Worker Safety Zone. The Communication Space is used primarily for the placement of fiber or cable used to deliver communication services.

Communication Worker Safety Zone – The space between the facilities located in the Supply Space and the facilities located in the Communication Space, both at the Pole and in the span between Poles. Spacing requirements for the Communication Worker Safety Zone are specified by the NESC.

Distribution System (or Distribution) – The portion of an electric power system that distributes electricity from a distribution substation to customers at individual metered or unmetered locations.

Foreign Pole – A utility pole that is not owned by AEP Texas.

Ground Furniture – The hardware used to maintain all Ancillary Equipment associated with an AEP Texas approved Wireless Telecommunication Attachment, which AEP Texas does not permit to be installed on the pole.



Make-Ready – Construction activities necessary to make a pole available for a new Pole Attachment, Pole Attachment modifications, or additional facilities.

Maximum Permissible Exposure (MPE) – MPE refers to the highest electric or magnetic field strengths, their squares or the plane-wave equivalent power densities associated with these field, or the induced and contact currents to which a person may be exposed without incurring an established adverse health effect, including an acceptable margin of safety.

Minimum Approach Distance – The minimum separation that shall be maintained between any person on, or proximate to the pole, and any RF-emitting Wireless Attachment, to reduce exposure to the uncontrolled MPE for such RF-emitting Wireless Attachment is not exceeded.

National Electrical Safety Code (NESC) – A United States standard of the safe installation, operation, and maintenance of electric power and communication utility systems including power substations, power and communication overhead lines, and power and communication underground lines.

Occupational Safety and Health Administration (OSHA) – Agency of the US Department of Labor that’s mission is to “assure safe and healthy working conditions for working men and women by setting and enforcing standards and by providing training, outreach, education, and assistance.”

Pole – AEP Texas’ poles supporting electrical conductors of less than 69kV, not including poles used solely for electric power Transmission, dedicated metal poles, street light poles, and all other special purpose poles or pole lines of non-standard design that do not support AEP Texas’ electric Distribution System.

Pole Attachment Agreement – Contract executed by AEP Texas and an Attacher that sets forth the terms and conditions pursuant to which such Attacher may obtain access to AEP Texas’ Poles, and the applicable rate(s) or rate formula(s).

Pole-Top – Pole space located at the top of the pole, in the Supply Space above the highest energized conductor.

Radiofrequency or “RF” – Electromagnetic radiation emitted by antennas.

Standards – collectively means AEP Texas’ Service Standards and the Joint Use Distribution Standards as may be amended from time to time.

Supply Space – The space on joint-use structures where supply facilities are separated from the Communication Space by the Communication Worker Safety Zone. Only AEP Texas authorized electrical workers are allowed to work in or above the Supply Space.

Telecommunications Service – The term “Telecommunications Service” shall be defined in 47 U.S.C. § 153(53).

Transmission – A high-voltage electric power system for delivering power, usually over long distance.

Unauthorized Attachment – Attachment on pole that Attacher did not receive approval to construct from AEP Texas. These Attachments are usually found during Pole Attachment Inventories.

Unusable Space – the space on any pole below the applicable minimum clearance requirement as defined by federal, state, or local regulations.



Wireless Telecommunications Attachment(s) (or “Wireless Attachment(s)”) – An antenna or antenna array, and all supporting cables, wires, hardware, support mounts, and any other communications equipment that AEP Texas may approve for installation on the same Pole, as is used to provide wireless Telecommunications Service, as that term is defined in Section 153(51) of the Communications Act.



PROCESS/PROCEDURE

This document includes forms, contact information for AEP TEXAS, and AEP TEXAS's General Design and Construction Guidelines for ease of use. All Attachments shall be designed, engineered, erected and maintained in accordance with AEP TEXAS's Standards; with the requirements and specifications of the NESC, including any grandfather-type provisions, amendments or revisions of the Code; and in compliance with any rules, regulations or specifications now in effect or that may hereafter be issued by the Federal Energy Regulatory Commission (FERC), the Occupational Safety and Health Administration (OSHA), or any other governmental body or authority having or exercising jurisdiction.

AEP TEXAS will periodically modify its processes and procedures, as AEP TEXAS deems necessary, including when there are changes to existing federal or state laws and regulations and/or decisions of regulatory or other administrative, judicial, or other legal proceedings that require such modifications. It is the responsibility of the attaching parties to ensure they have the latest version of AEP TEXAS's Joint Facility Attachment Processes/Procedures document and to comply with the processes and procedures therein when seeking attachment to AEP TEXAS facilities. In all situations, it is the ongoing responsibility of the Attacher to be familiar with and adhere to the NESC and this document during installation, maintenance, and related activities involving their Attachments to AEP TEXAS's Poles. Any Attachment found to be in violation of the NESC, any provision of these processes, AEP TEXAS's Standards, or applicable law may be subject to removal by AEP TEXAS at the sole cost of the Attacher. The portions of this document relating to design and construction of Attacher's facilities in proximity to AEP TEXAS's Distribution System are intended to be in compliance with the NESC; provided, however, that any provision of this Policy that is inconsistent with the NESC, the more stringent shall apply.

AEP TEXAS will not tolerate Unauthorized Attachments to its facilities. If AEP TEXAS discovers an Unauthorized Attachment, AEP TEXAS may remove, with or without prior notice, any, or all of the Unauthorized Attachments and charge the attaching party for all removal, storage, and disposal fees. In addition to any other rights and remedies to which AEP TEXAS may be entitled for an Unauthorized Attachment at law, in equity and/or under any existing Pole Attachment License Agreement, AEP TEXAS is entitled to an Unauthorized Attachment Fee as calculated below:

- a. **Fee for No Executed Pole Attachment License Agreement.** Five Hundred Dollars (\$500) for each pole where there was no Pole Attachment License Agreement for the Unauthorized Attachment.
- b. **Fee for No Permit.** An amount equal to five (5) times AEP TEXAS's current annual Pole Attachment Fee if a Permit was not issued by AEP TEXAS and the violation was self-reported or discovered through a joint inspection and accompanied by an Application for approval of the Attachment.

In addition to the amounts set forth above, AEP TEXAS is also entitled to recover all other costs incurred not covered in the annual Pole Attachment Fee.

Application/Approval Process For Joint Use Pole Attachments

AEP TEXAS is required by the Pole Attachment Act, 47 U.S.C. § 224, to provide telecommunications and cable television service provider's access to its poles for the purpose of attaching communications cables/equipment. This document in combination with AEP TEXAS's Pole Attachment License Agreement will set forth the terms and conditions for the aforementioned Attachments in concurrence with AEP TEXAS's Standards. Notwithstanding AEP TEXAS's limited obligation to provide access to its Poles, permission to make an Attachment to any Pole or Poles may be denied at the sole discretion of AEP TEXAS,



where insufficient capacity exists, or for any reason related to safety, reliability, and generally accepted engineering practices.

No Attachments may be made to any of AEP TEXAS's facilities before AEP TEXAS issues a written Permit/Notice to Proceed allowing such Attachment. In order to begin this process, a formal Application must be submitted to AEP TEXAS's Joint Use Representative. Before submitting an Application to attach to AEP TEXAS's facilities, please read this document as well as AEP TEXAS's Pole Attachment License Agreement in its entirety so you understand your rights and responsibilities.

The Joint Use Representative will be the contact for all activities relating to Attachments to AEP TEXAS facilities, including the application for such permits, maintenance, joint use requests, and the collection of the appropriate fees.

Application

If you do not currently have a Pole Attachment Agreement with AEP TEXAS to attach to our Distribution poles, please contact: **Curtis Austin**, Joint Use Representative, at claustin@aep.com to apply for an agreement.

A party with an active agreement with AEP TEXAS (referred to herein as both the "requesting party" and the "attaching party") must apply for a Permit by submitting a design package prior to any construction or attachment activities involving AEP TEXAS facilities. This design package shall be submitted via one of the following methods:

- a. Request through the AEP JU Portal at <https://aepjuportal.azurewebsites.net/Account/Login>. Access via the Portal can be granted by contacting the Joint Use Representative.
- b. Permission to Attach (Proposal) form, which is available upon request. A maximum of 50 Attachments on each Proposal is allowed for manageable processing via this form. The completed form and maps may be submitted to cregionpoleattachment@aep.com.

Proposals

- a. Please note that by signing the Proposal or submitting through the AEP JU Portal, the requesting party agrees to pay all of AEP TEXAS's fees associated with the request regardless of whether they ultimately attach to AEP TEXAS's facilities.
- b. Map indicating the location of the poles and the route in which the communication cables will be routed.
- c. Drawings and specifications of the Attachment. These should illustrate:
 - a. The stringing tension
 - b. The cable weight and diameter
 - c. The proposed location of the Attachment
 - d. How the Attachment will be connected to the pole and
 - e. If attachment is an antenna, antenna specs will need to be provided for RF and structural analysis (see **Wireless Antenna Standard** section)

Should the design require more than 300 poles please contact **Curtis Austin**, Joint Use Representative, at claustin@aep.com to provide a current route map and discuss processing timelines.

General Pole Attachment guidelines, including AEP TEXAS's Standards, are included in Section 3 (Installation Standards) of AEP TEXAS's Pole Attachment License Agreement. However, the design of the Attachment(s) must also comply with the NESC, regulations or specifications issued by the FERC, the OSHA, and any other applicable law, ordinance, or regulation.



Response

AEP TEXAS will review your Request / Proposal for completeness when received and will respond within 10 business days if there is missing information. Please indicate on your request if you are requesting One-Touch Make-Ready (“OTMR”) access. In the JUA Portal, this will be noted by selecting “Simple”. Approval for OTMR will only be granted for Simple make-ready and where no other make ready is required. OTMR requests that require Complex make-ready will be deemed as Non-OTMR and Proposals will be processed by AEP TEXAS, or a representative thereof, by performing an analysis on each pole including clearances, strength, and capacity. The requesting Attacher will be notified of the date when data collection will begin and AEP TEXAS will take the applicable steps to meet the required FCC timelines for engineering.

AEP TEXAS will provide a written response to each completed Application within forty-five (45) days of receipt for a regular submission and sixty (60) days for a Large or Very Large Submission, as defined in the Pole Attachment License Agreement. During this time, AEP TEXAS may conduct a Survey to determine if Make Ready Work will be required.

An estimate for all AEP TEXAS pole rearrangements and/or replacement work (Make Ready Work) necessary for the approval of the Proposal will be provided to Licensees for review, with approval and payment in advance of work being scheduled or performed as contractually required. An approver will need to be provided to AEP TEXAS prior to Proposals being submitted for invoicing.

- a. Make Ready Work – If Make Ready Work is required, AEP TEXAS will issue a Make Ready Estimate within fourteen (14) days of issuing a written response to the completed Proposal. The requesting party must then approve the Make Ready Estimate and provide payment within fourteen (14) days.
- b. Approval of Request – All of the costs incurred by AEP TEXAS, including but not limited to engineering, contractor, inspection, and Make Ready costs must be paid in full before approval will be granted. Once approval is granted, AEP TEXAS will issue an Authorized Proposal. Please note that verbal communications shall be construed as authorization or approval.
- c. Denial of a Request – AEP TEXAS reserves the right to deny any Attachments that fails to comply with AEP TEXAS’s specifications; where there is insufficient capacity on the Pole for the Attachment; or for reasons of safety, reliability, or generally applicable engineering standard concerns that may not be resolved through Make Ready or other reasonable means such as re-arrangement of facilities. If AEP TEXAS denies the Proposal, a Denied Proposal notice will be issued.
- d. Self-Help Remedy – Should a Licensee decide to invoke their self-help remedy for either engineering or make-ready construction, a written notice must be provided to the Joint Use Representative. Licensee must use an approved AEP TEXAS contractor for all work undertaken.

All information exchanged between AEP TEXAS, Licensee, and Licensee’s representatives, contractors and subcontractors is considered confidential. Any unauthorized reproduction of AEP TEXAS information or disclosure of any maps and or documents, in print or electronic format, is strictly forbidden without the express written consent of AEP TEXAS.



Installation and Maintenance

The attaching party shall, at its own risk and expense, make and maintain its Attachments in a safe condition and in good repair, in a manner reasonably acceptable to AEP TEXAS, according to the approved design stated in the Approved Proposal. During the process of making and maintaining its Attachments, the attaching party shall not act in a manner which unreasonably conflicts with the use of AEP TEXAS's poles by AEP TEXAS or by others lawfully using such poles or interfere with the working use of facilities thereon or which may from time to time be placed thereon by AEP TEXAS or others.

Completion of the Attachment

Within fifteen (15) days after completion of the Attachment, written notice must be given to AEP TEXAS by countersigning and returning the Authorized Proposal Form. Unless otherwise specified in writing, the countersigned Proposal Form should be sent via electronic mail to cregionpoleattachment@aep.com.

Post Construction Inspection

AEP TEXAS or its agent may then Post Construction Inspect the completed installation. (This inspection, however, shall not relieve the parties of any responsibility, obligation, or liability assumed under the Pole Attachment License Agreement.)

If during an inspection AEP TEXAS discovers the Attachments are not in compliance, the requestor shall correct such nonconformance within thirty (30) days of written notification unless there is an immediate risk of personal injury or property damage, in which case corrective action shall be taken immediately. In addition, if the inspection reveals that the as-built Attachments do not match the original design, AEP TEXAS or its approved contractor may make the appropriate modifications at the expense of the requestor.



GENERAL DESIGN AND CONSTRUCTION GUIDELINES

Structure of the Distribution Pole and Working Zones

In all situations, it is the ongoing responsibility of the Attacher to be familiar with and adhere to the NESC definitions, rules, and criteria related to all sections of a distribution Pole.

The Distribution Pole includes:

- Pole-Top
- Supply Space
- Communication Worker Safety Zone
- Communication Space
- Unusable Space

The Pole-Top is the Pole space located at the top of the Pole, in the Supply Space above the highest energized conductor.

The Supply Space is reserved for electrical supply facilities where exposed high voltages are present. The Supply Space may include separate facilities operating at different voltages; for safety reasons, the highest voltages are, generally, located uppermost on the pole.

Communication Worker Safety Zone is the safety zone, or “neutral” space, between the lowest electrical supply conductor or equipment and the highest communication cable or equipment.

The Communication Space is the portion of pole in which communication fiber, cables, and antennas are attached.

The Unusable Space is the space on the pole below the applicable minimum clearance requirement as defined by federal, state, or local regulations. For reasons of safety and reliability, AEP TEXAS does not permit non-utility equipment of any kind to be affixed to its poles within the Unusable Space.

Design

Before submitting a Proposal to Attach, the requestor should ensure that it has complied with all of the following guidelines:

- The attaching party must stay above ground for a minimum of 10 poles before terminating to underground. This reduces the number of guy wires on AEP TEXAS poles.
- Installation is limited to communications facilities; no electrical systems other than those of AEP TEXAS may be installed on AEP TEXAS poles, through use of this process.
- All facilities shall be installed in accordance with AEP TEXAS’s Standards, the NESC and other applicable regulations, laws, and ordinances.
- If a pre-existing violation is identified, additional cables may only be installed if they meet clearance requirements.
- Attaching parties may overlash additional cables to their existing cables as long as written notification is given to AEP TEXAS 15 days in advance of attachment and within 15 days of attachment completion. Overlashes will be subject to post-installation inspections and may require a Pole Load Analysis based on AEP TEXAS’s judgment at Licensee’s expense.
- Overlapping does not include the installation of any strand-mounted equipment. These shall be permitted separately.



- All Attachments shall comply with the minimum horizontal and vertical clearances listed in the NESC and AEP TEXAS Standards.
- Down guying should only be used where required, i.e. dead end poles, corner poles, etc. Attaching parties will not be allowed to skip poles, which results in excess guying and compromises the integrity of AEP TEXAS facilities.
- Only poles owned by AEP TEXAS may be installed on AEP TEXAS property or designated right-of-way without formal written approval.
- The requestor must secure access rights with any landowner and/or government agency prior to attaching to AEP TEXAS owned poles. It should not be assumed that access is granted based on the presence of AEP TEXAS owned pole or the written approval to attach to AEP TEXAS's facilities. When attaching to any poles in State, County, or City rights-of-way the attaching party must contact those entities for permits prior to attachment/construction.
- The messenger wire for cable Attachments must be grounded per the NESC. If the attaching company chooses to run their own ground wire they must attach to AEP TEXAS's ground wire at the base of the pole.
- Communication cables and antennas must be installed on the same side of the pole as AEP TEXAS's secondary and neutral conductors and/or any existing cable Attachments. In the absence of these cables on the poles, the Attachments must be made on the street side of the pole. The unauthorized use of Horizontal Extension Arms is prohibited. Horizontal Extension Arms shall only be installed under the explicit authorization of AEP TEXAS. Horizontal Extension Arms shall not be used by Attachers to attempt to gain a horizontal separation from existing attachments or electrical conductors where vertical clearances are specifically required by AEP TEXAS Standards, NESC, or applicable law.
- Communication cables, antennas, and other equipment may not be installed using extension arms, standoff brackets, or similar hardware, unless otherwise approved by AEP TEXAS.
- To preserve the safe and reliable condition of AEP TEXAS's Distribution System, Attachments may not be permitted on Poles that, at the time of Attacher's application, support certain mission critical electrical power delivery equipment, including but not limited to transformers, sectionalizers, switching devise, reclosers, regulators, capacitor banks, riser poles, or poles with any AMI related equipment.
- Service Drops are to be no more than 3 spans before dropping to the customer's premise. The cable/fiber is to be secured to the pole using a through bolt except for the last pole where the service to customer may come off the pole with a j-hook.
- Service Drops are to be taken off the strand at least 15 inches from the vertical surface of the pole using a crimp-on method. Where there is no strand, the service can utilize j-hooks or similar equipment.
- If multiple attachments to the pole are found, a charge for additional attachment will be incurred.
- Attachments to AEP Transmission poles without Distribution under-build is prohibited. AEP Transmission has the right to deny any Transmission pole replacement regardless of Distribution under-build. However, consideration for AEP Transmission pole requests will be forwarded to AEP's Transmission Department for review. All expenses for this review are at the expense of the proposing Communication Company. Attachment reviews on Transmission facilities are significantly more expensive and time-consuming than reviews typically performed on Distribution poles.



Construction

Attaching parties are required at all times to adhere to the following while working on AEP TEXAS poles:

- Crew must be able to show evidence of permission to attach or maintain third party owned facilities on AEP TEXAS poles. This should include a copy of the written Authorized Proposal, Pole Attachment License Agreement, or other documentation issued by AEP TEXAS.
- All Attachments must adhere to the clearance requirement outlined in AEP TEXAS's Standards.
- Communications cables must be properly guyed and anchored before tensioning. AEP TEXAS's guys or anchors shall not be utilized. Communication cable guying must maintain a minimum of 6' of separation from AEP TEXAS's guys or anchors.
- Attaching parties will be responsible for any damage caused to AEP TEXAS's facilities for failure to guy properly.
- Communication cables, risers, vertical runs, and ILEC multiple mainline Attachments must be properly identified and tagged at appropriate intervals.
- Antennas shall have contact 24x7 contact information provided at each location.
- Any excavation work, including the installation of ground rods and anchors, requires a call to the local one-call system 48 hours in advance of any digging to locate all underground facilities. 811 Call Before You Dig.

The attaching party is responsible for complying with the NESC, regulations or specifications issued by the Federal Energy Regulatory Commission, the Occupational Safety and Health Administration, and any other applicable law, ordinance or regulation.

While the attaching party is responsible for complying with the entire NESC, the applicable sections include, but are not limited to, the following sections:

Part 2 – Safety Rules for the Installation and Maintenance of Overhead Electric Supply and Communication Lines;

Section 22: Relations Between Various Classes of Lines and Equipment;

Subsection 220D – Identification of Overhead Conductors and

Subsection 220E – Identification of Equipment on Supporting Structures

Part 4 – Rules for the Operation of Electric Supply and Communication Lines and Equipment;

Section 41 – Supply and Communication Systems – Rules For Employers;

Subsection 411E – Identification and Location

Wireless Attachment Standard

This section applies to all third party Wireless Attachments made to AEP TEXAS Poles. The guidelines and requirements set forth herein are intended to protect the public, the employees and/or contractors of AEP TEXAS, and other entities that may be authorized to access AEP TEXAS Poles, all of whom may be exposed to hazards presented by third party Wireless Attachments.

Equipment specifications for each type of proposed wireless device shall be evaluated and approved by AEP TEXAS.



All Pole locations shall be evaluated and approved by AEP TEXAS prior to Antenna or Ancillary Equipment installation. All applicable Pole Attachment contracts shall be executed and approved before Antennas will be allowed to attach.

It is understood that a single Wireless Attachment shall be comprised of no more than one piece of equipment contacting the Pole; however, such equipment may contain multiple antennas, and multiple bandwidths, each requiring a separate cable affixed to the Pole. The aggregate shall conform to AEP TEXAS's Standard in effect at the date of submittal.

Batteries, Ground Furniture, and other Ancillary or supporting equipment that Attacher is required by AEP TEXAS to maintain on the ground do not comprise its Wireless Attachment.

AEP TEXAS reserves the right to disconnect electric service to any Wireless Antenna at any time if established Minimum Approach Distances cannot be maintained while work is being performed.

Wireless Attachments will be permitted only on AEP TEXAS Distribution Poles. No Wireless Attachment will be permitted on any other pole that is not subject to the requirements of Section 224 of the Communications Act (47 U.S.C. § 224). Antennas are preferred to be mounted on unencumbered wood Distribution Poles. Because of allowable space and safety, secondary Poles or guy stub Poles are given preference. Replacement Poles are typically 10 to 15 feet taller to allow room for RF signs, RF clearance, etc.

Each Pole selected for a Wireless Attachment shall be located in the road right-of-way (ROW), and shall be truck accessible throughout the year. If the Pole is on private property, AEP TEXAS shall require property research and proof of easement prior to starting a design to replace a Pole.

Each individual Wireless Attachment shall be installed on the Pole for which the installation was approved. All Make-Ready required to make space for Attacher's Wireless Attachment, or any Pole replacement, shall be at Attacher's sole cost and expense.

No Wireless Attachment (or supporting equipment) shall be permitted in the Unusable Space, or the Communication Worker Safety Zone.

No more than one Wireless Attachment will be permitted on any individual Pole.

No Wireless Attachment may be installed at any location, or in any manner that would, in AEP TEXAS's reasonable judgment, impair its employees and contractors from ascending or descending any Pole, or from accessing any Pole Top.

All supporting equipment, including, but not limited to the power disconnect switch, batteries, power meters and any other back-up power sources, all radio equipment and access nodes, electronic equipment shelters and all equipment in such shelters, pedestals, supporting equipment cabinets or panels, and other necessary or Ancillary Equipment that supports the Wireless Attachment shall be placed in Ground Furniture.

Grounding of all Wireless Attachments shall be in strict accordance with the NESC.

The minimum vertical distance between any Pole Top Wireless Attachment and the highest conductor on the Pole shall be the greater of five feet or the Minimum Approach Distance, based on such Attachment's RF emissions.



All equipment physical, electrical, and other characteristics including but not limited to those listed, shall be provided to the AEP TEXAS representative:

- Total assembly weight, cubic feet
- Electrical characteristics
- Transmitted power
- Operating voltage
- Antenna gain
- Antenna pattern
- Is any part of the wireless equipment a “communications line” as defined in Section 2 of the NESC?
 - Used for public or private signal or communications service
 - Potential less than 400V to ground or 750V between any two points of the circuit
 - Transmit power of less than 150W

The following equipment information shall be provided to AEP TEXAS prior to, or concurrent with the pre-application RF Analysis:

- Company Information (Site Name, Company Name, Address, Contact Name, Contact Telephone/Email);
- % Maximum Permissible Exposure (Uncontrolled and Controlled)
- System Information (Model/Name, Location of Attachment on Pole, Transmit Frequency, Power, Max ERP, Antenna Center Line, Antenna Gain, Beamwidth, Signal Direction, modulation technique of the transmitter)

Because AEP TEXAS does not permit vertical Pole-Top extensions, replacement of the Pole is required in nearly all cases to establish sufficient vertical clearance to accommodate a Pole-Top Wireless Attachment. In such cases, AEP TEXAS will, at Attacher’s request, and at Attacher’s sole expense, replace the existing Pole with a taller Pole, up to sufficient capacity to support the Pole-Top Wireless Attachment.

All antenna installations shall be unmetered.

Attachment of lockable disconnect switches on AEP TEXAS Poles is prohibited. Lockable disconnect switches shall be installed off-pole on a non-AEP TEXAS owned pole, pad, or pedestal. The lockable disconnect switch shall be permanently labeled to identify the equipment it controls and the equipment owner.

Pole-Top Wireless Attachments and Communication Space Wireless Attachments shall be connected to communications equipment separately located in Ground Furniture by cable encased in vertical conduit on the side of the Pole.

Each device that Attacher intends to be installed on AEP TEXAS’s Poles shall be subject to a one time, pre-application RF analysis to determine whether such device operates within uncontrolled Maximum Permissible Exposure (“MPE”) limits at its maximum output. Such RF analysis shall be prepared by an independent, certified third party contractor, at Attacher’s sole expense. The attacher shall provide AEP TEXAS with a 3rd party RF study (signed by a P.E.) prior to AEP TEXAS starting a design to replace a Pole.

A (P.E. signed) Utility Worker Safety Letter is also required that clearly states the safe RF range, from the Antenna, based on the 3rd party RF study.



All supporting documents are required prior to design. AEP TEXAS cannot reserve space for an attacher's future attachment.

AEP TEXAS will not obtain or negotiate any property rights for the benefit of Attacher, and makes no guaranty of that such rights will be granted by the owner of property on which AEP TEXAS's Poles may be located. The attacher is responsible for obtaining local approval for Antenna Pole locations from the appropriate County, Municipal, or State Authority. AEP TEXAS shall require approval documents prior to designing a job to replace a Pole.

Antennas are not to be installed above primary in areas which are considered "salt contaminated" areas. In these areas, AEP TEXAS will allow installations only on secondary Poles.

Antenna equipment is permissible on wood Poles or (specifically manufactured) composite streetlight poles only.

Antennas are not permitted on poles where four (4) quadrants of Pole space (around the circumference of pole) are taken or would be taken to bring pole up to current AEP TEXAS engineering standards.

If there are more than one riser shield present on the Pole, the Pole shall be rejected.

Antenna riser shields shall be a continuous straight line for the entire length of the Pole. For this reason, guyed Poles may be rejected.

Only non-metallic electric grade conduit or risers can be used for routing communication cables through the Supply Space and shall not obstruct working space on the Pole.

Antennas are not permitted on Poles with other cabinets such as a cable TV power supply or an existing meter base.

All radio heads, diplexers, amplifiers, or any other equipment shall not be at the top of the Pole. All equipment shall be in the equipment case at the bottom of the pole. This pad-mounted equipment shall be a minimum of six (6) feet from the base of the pole to reduce the likelihood of touch potential.

All modifications to Wireless Attachments will be subject to AEP TEXAS's prior approval. Such modifications include, but are not limited to:

- Frequency
- Power
- Gain
- Equipment Type
- Location
- Exposure Data

If an RF-emitting device does not operate within the uncontrolled MPE, the following will be required:

- Attacher shall train (or ensure the training of) all of its employees, contractors, and sub-contractors who will work on, or proximate to Wireless Attachments.
- Attacher shall be responsible for installing and maintaining RF safety signage, in accordance with the following:
 - Signs shall be in accordance with IEEE Std C95.2 [B19] and ANSI Z535 [B4], and placed in accordance with IEEE Std C95.7.



- Attacher shall affix two (2) signs on each Pole that contains a Wireless Attachment. Each such sign shall be flush-mounted to the Pole, as to ensure that it does not impair AEP TEXAS's employees and contractors from ascending or descending any Pole, or from accessing any Pole-Top.
- A Notice/Information sign shall be placed at least two (2) times the Minimum Approach Distance below the Wireless Attachment, and shall include information sufficient to warn the public that an RF-emitting device is on the Pole.
- An RF Safety sign shall be placed at a vertical distance below the Wireless Attachment that is equal to the Minimum Approach Distance, and shall indicate the RF hazard and the Minimum Approach Distance.
- Each sign shall clearly indicate Attacher's name and a telephone number where a representative of Attacher can be reached, twenty-four (24) hours a day, seven (7) days a week to respond to questions, or to any reports of problems with the Wireless Attachment.
- Attacher shall install and maintain operational a disconnect switch, on site, that enables AEP TEXAS to power down the Wireless Attachment without the need for Attacher's intervention including battery power.
 - Such disconnect switch shall be maintained in Ground Furniture.
 - In all cases, Attacher will be required to re-power its own Wireless Attachment.

In the event AEP TEXAS determines, in its sole judgement, that any Wireless Attachment(s), or the condition of any Wireless Attachment(s): (i) interferes with AEP TEXAS's use of any Pole, or the operation of any of AEP TEXAS's facilities or equipment; (ii) constitutes a hazard to the service rendered by AEP TEXAS or by any third parties authorized by AEP TEXAS to use its Pole(s); or (iii) causes any danger to AEP TEXAS's employees, contractors, or subcontractors of any tier, or employees, contractors, or subcontractors of any tier of any third parties authorized by AEP TEXAS to use its Poles(s), or to the public, Attacher or Attacher's designee shall be present at the affected Pole location and available to begin work to remediate the situation within four (4) hours of receiving AEP TEXAS's written or oral of the same, and shall expeditiously finish such work.

In the event that that any hazardous or unsafe condition described above requires AEP TEXAS, in its sole discretion, to immediately remove, relocate, or disable any Wireless Attachment, AEP TEXAS reserves the right to take any such remedial action without prior notice to Attacher, and without liability to Attacher.

Removal and Abandonment

Attacher shall bear all costs of removal and any AEP TEXAS costs incurred as a result of such removal, and shall continue to pay all attachment fees due to AEP TEXAS under the applicable section of the Attacher's Pole Attachment Agreement up to and until the date on which such Attachment(s) have been removed from the abandoned Pole(s).

Communication Attachments on Distribution Pole with Streetlight

AEP TEXAS will consider attachment to Distribution Poles with streetlights on them subject to the same criteria that would be applied for requests to attach to other Distribution Poles. All Attachment requests are subject to review for safety, reliability, engineering practice, and capacity concerns. AEP TEXAS shall not permit any third party communication attachments to any pole that is not part of its Distribution System without express written consent.

Identification Guidelines / Tagging Requirements

To ensure that attaching parties are promptly notified during an emergency, AEP TEXAS requires that cables, antennas, boxes, and other equipment be identified with tags depicting the following:

- Attaching company's recognizable name
- Identifiable company logo
- Emergency telephone number / contact information

Cables should be tagged at 1000' intervals between poles, and on dead end and termination poles. In addition, cables should be tagged more frequently in highly congested areas.

Cables, antennas, boxes, and other equipment shall be tagged at the time of installation. Attaching parties must also assist in the identification effort by tagging all existing cables, antennas, boxes, and other equipment.

Attaching parties shall use "billboard tags" to label all Attachments in the color designated by AEP TEXAS in AEP TEXAS's Standards. In addition, all tags should:

- Be secured so as to remain permanently affixed to the cable.
- Be resistant to the effects of fading from weather, chemicals, etc.
- Be consistent in appearance throughout AEP TEXAS's territory.
- Have a font that is legible from ground level.
- Avoid the uses of sharp edges to prevent injury to personnel or equipment

Example:

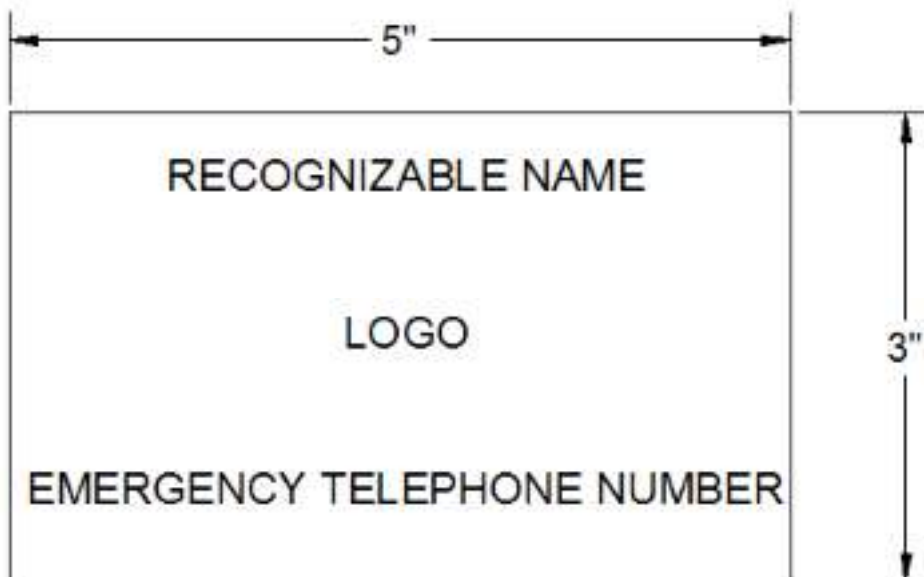

Safety

Safety is the top priority for all parties involved in pole Attachments. This policy sets out procedures to ensure that AEP TEXAS poles and Licensees' Attachments are operating in the safest manner possible. Attaching parties are reminded that AEP TEXAS poles are part of an electric transmission and Distribution



System. The attaching party and its employees, agents, contractors and employees of contractors shall assume that lines are energized and take all necessary precautions when working on or near our facilities.

AEP TEXAS requires attaching parties to educate or confirm the training of its employees and agents regarding the safety precautions to be utilized during the installation, construction, maintenance, use or removal of any Attachment on AEP TEXAS's poles and shall specifically warn or confirm that its employees and agents have been warned of the dangers of coming into contact with the electric lines of AEP TEXAS, including the fact that serious bodily injury, including death, can occur as a result of any such contact.

Prior to the commencement of any Attachment, the attaching party, its agents, and contractors shall inspect the work area on or near AEP TEXAS's poles specifically to ascertain the actual and potential existence and extent of any hazardous or dangerous conditions. The attaching party, its agents, and contractors shall then instruct its supervisors and employees with respect to any such conditions and the safety measures to be taken in connection therewith and shall take all such measures deemed necessary or prudent to protect and safeguard the person and property of their employees and the general public against all hazardous or dangerous conditions that may arise during the course of the work. If visible inspection of a facility causes concern, please contact AEP TEXAS at 1-866-223-8508 (the AEP Texas Outage Phone line) before approaching the facility or proceeding any further. Remember, when in doubt, stop.

An attaching party, its agents, and contractors must obtain authorization from AEP TEXAS prior to performing any work within the Supply Space. In addition, if the attaching party, its agents, or its contractor finds that it must violate the Communication Worker Safety Zone while performing construction or maintenance activities, it must contact AEP TEXAS at 1-866-223-8508 prior to performing the work so that safety precautions can be taken. For example, AEP TEXAS can arrange to cover, de-energize, or move electrical lines to protect and safeguard persons and property. In addition, work performed outside the Communication Worker Safety Zone must be performed by a qualified contractor that has been pre-approved by AEP TEXAS. In both instances, the attaching party may not proceed without express approval from AEP TEXAS.

Safety Regulations and Requirements

The attaching party and its employees, agents, contractors and employees of contractors must follow all of the of the Occupational Safety and Health Administration (OSHA) regulations. While all of the applicable OSHA regulations must be followed, please pay particular attention to OSHA Title 29, Part 1910.180, 1910.333, 1926.416, 1926.417, and 1926.500.

Emergency Situations

In the event that equipment or persons make contact with an energized line please contact emergency personnel at AEP TEXAS at 1-866-223-8508 and 911. Be prepared to provide the location as well as a brief description of the incident.

Pole Warning Markers

AEP TEXAS inspects a percentage of poles each year as part of its pole inspection program. During this inspection, poles may be marked with one or two square metal tags. These tags indicated that the pole needs to be replaced and it is not safe for climbing.



Poles marked with an oval or circular tag displaying a year were inspected in that year and are deemed safe to climb. Please see Appendix 15 for examples.

Pole Treatment

AEP TEXAS poles have been treated with some form of wood preservative, which protects against rotting and insect damage. This treatment is used to extend the life of the pole. In most cases pentachlorophenol is used, however chromated copper arsenate, CCA, has been used as well. The chemicals may cause skin irritation through contact with the skin. Therefore, AEP TEXAS recommends that protective clothing and gloves be worn at all times while working on or around AEP TEXAS facilities. Should a person contact the pole with bare skin or incur a splinter while working, promptly remove the splinter and flush the skin with soap and water to remove the chemical.

Duty to Inspect

The attaching party expressly assumes responsibility for determining, and has a duty to determine the condition of all poles to be climbed by its employees, agents, contractors or employees of contractors. As such, the attaching party assumes all risk of loss, damage or injury to person or property of its employees, agents, and contractors related to the condition of any pole to which its Attachments are made, except to the extent such loss, damage or injury is caused by AEP TEXAS's gross negligence or intentional misconduct.

AEP TEXAS Standards and Specifications

AEP TEXAS has provided its construction specifications as a reference for attaching parties to use as a guide when attaching to AEP TEXAS's facilities. While AEP TEXAS has provided these specifications, they do not supersede the NESC, regulations or specifications issued by the Federal Energy Regulatory Commission (FERC), the Occupational Safety and Health Administration (OSHA), or any other applicable law, ordinance, or regulation. It is the responsibility of the attaching party to be aware understand and comply with all of the applicable requirements.

CONTACT INFORMATION

AEP TEXAS Contacts

If you are initiating a new Attachment request, please contact our Joint Use Department through either the [JU Portal](#) or cregionpoleattachment@aep.com.

If you have not received a response from our Joint Use Engineer within five business days, you may contact the Joint Use Representative to obtain the status of your request.

Joint Use Representative: Curtis Austin

E-mail: claustin@aep.com

Should a Licensee decide to invoke their self-help remedy for either engineering or make-ready construction, a written notice must be provided to the Joint Use Representative. Licensee must use an approved AEP TEXAS contractor for all work undertaken.



Selection of Qualified Contractors

Attachers are responsible for verifying the qualifications of all contractors retained to install, maintain, or repair their Attachments, or to perform Make-Ready requested by a third party in the Communication Space. Attachers and their contractors shall comply with the minimum qualifications for contractors established by the FCC, and shall perform all work in conformance with the NESC, OSHA, and all applicable law. AEP TEXAS shall maintain separate lists of pre-approved contractors for engineering and Supply Space Make-Ready. All Supply Space Make-Ready shall be performed by AEP TEXAS, or by an AEP TEXAS-approved contractor identified on the list maintained by AEP TEXAS for Supply Space Make-Ready. All pole replacements and work above the Supply Space shall be controlled by AEP TEXAS.

These lists may be updated from time to time, to add or remove contractors consistent with the provisions of these Guidelines.

Approved Engineering Contractors

AEP TEXAS currently has approved the use of the following contractors for engineering review of proposals:

- TechServ Consulting & Training, Ltd
- Pike

AEP TEXAS will perform all engineering reviews using internal resources or one of the above contractors.

Approved Contractors to Work in the Supply Space

AEP TEXAS currently has approved the use of the following contractors for work performed above the Communication Space:

- Line Tech
- KV Power
- High Power
- Can-Fer
- Chain Electric

Additional crews for these contractors required for the sole purpose of performing the attacher's work will be required to have Safety Onboarding performed by AEP Texas at the sole expense of the attacher. Any qualified observer, cover up, or additional work for the sole purpose of performing the attacher's work shall be at the sole expense of the attacher.

Additional Vendors not on the above list to work in the Supply Space may be considered. Please contact the Joint Use Administrator for the process to qualify which includes a subscription to the VERO Data Management System operated by Safety Management Group (SMG).

Appendix

Appendix 1 - Cable Clearance

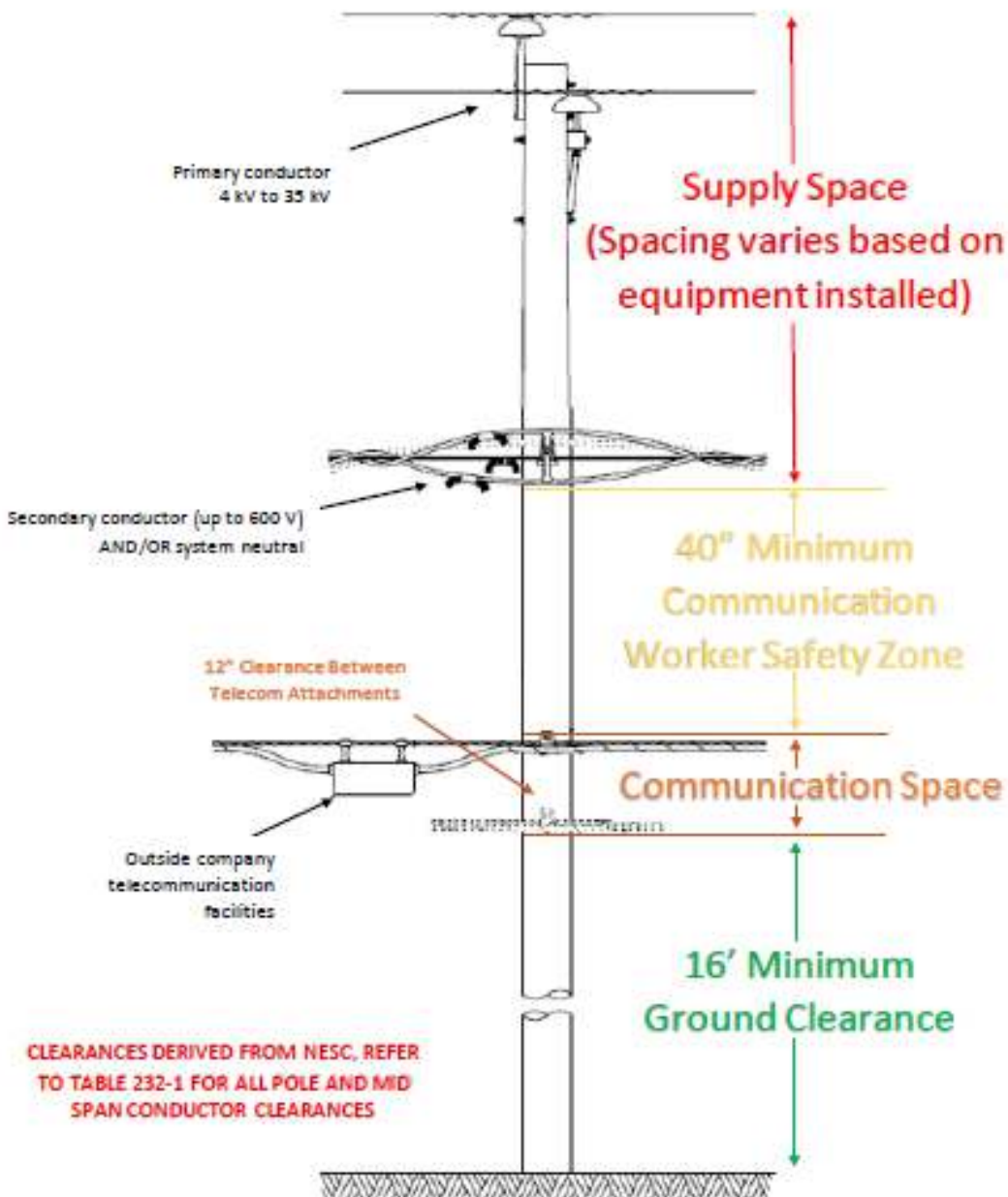

Appendix 2– Ground Wire Installation

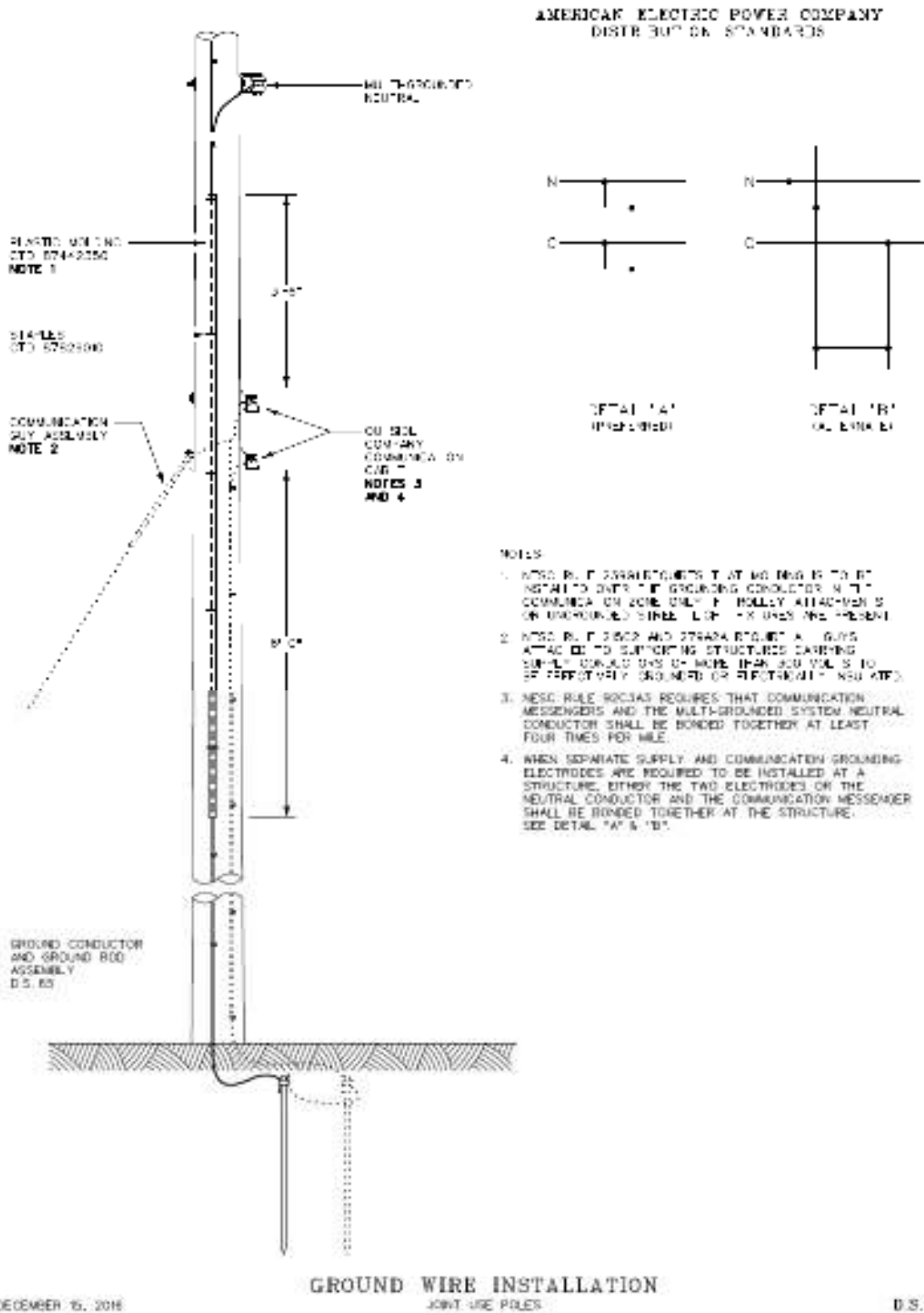

Exclusively for AEP approved parties, not to be copied nor distributed without written approval

Appendix 3 – Conduit Stand-off Bracket

AMERICAN ELECTRIC POWER COMPANY DISTRIBUTION STANDARDS

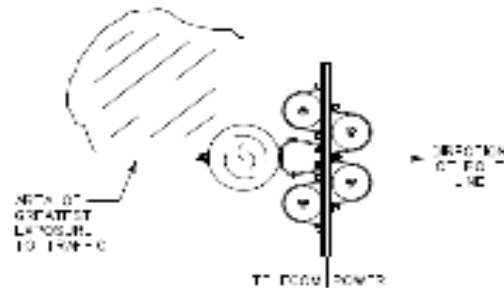
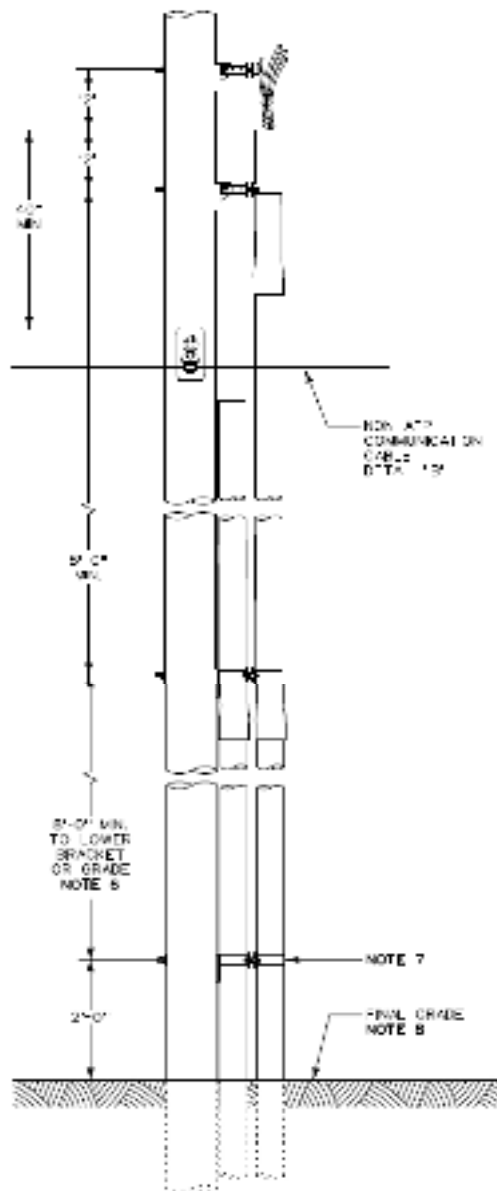

DETAIL 'A'
 CONDUCTOR OR CONDUIT SUPPORT
 ASSEMBLY INSTALLATION
 NOTES 1 THRU 4

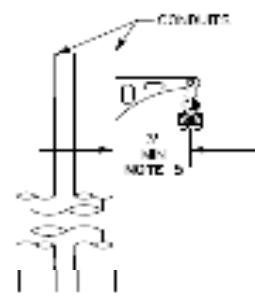

DETAIL 'B'
 NON AEP COMMUNICATION CABLE
 ON MULTIPLE CONDUIT INSTALLATIONS

NOTES:

1. FRONT OF CHANNEL IS FOR POWER.
2. BACK OF CHANNEL IS FOR TELECOMMUNICATION. CONSIDERATION SHOULD BE GIVEN FOR FUTURE ATTACHMENTS BY USING THE SPACE CLOSEST TO THE SUPPORT. THREE INCHES MINIMUM CLEARANCE MUST BE MAINTAINED BETWEEN THE POLE AND THE CONDUIT FOR CLIMBING EQUIPMENT.
3. EACH TELECOMMUNICATION CONDUIT SHALL BE CLEARLY MARKED TO INDICATE OWNERSHIP.
4. ONLY ONE RISER ASSEMBLY IS PERMITTED ON THE POLE.
5. COMMUNICATION CABLE SHALL PHYSICALLY CLEAR STANDOFF RISER BY THREE INCHES MINIMUM REFER TO DETAIL 'B'. COMMUNICATION STANDOFF BRACKET IS ONLY TO BE USED ON RISER STRUCTURES TO OBTAIN THE REQUIRED CLEARANCE. THE STANDOFF BRACKET IS NOT TO SUPPORT MULTIPLE CABLES.
6. CONDUIT SUPPORTS TO BE EVENLY SPACED, AT LEAST EIGHT (8) FEET APART TO KEEP FROM BEING READILY CLIMBABLE (INSC 217A20).
7. LOWEST STANDOFF BRACKET IS NOT REQUIRED IF CONCRETE ENGAGEMENT IS USED.
8. PAD-MOUNTED EQUIPMENT, PEDESTALS, AND ANY OTHER ABOVE GROUND ENCLOSURE, SHOULD BE LOCATED NOT LESS THAN FOUR (4) FEET FROM THE POLE, UNLESS A JOINT WRITTEN AGREEMENT IS OBTAINED.

CONDUIT STANDOFF RISER FOR JOINT USE TELECOMMUNICATION 4 THRU 35KV

SEPTEMBER 15, 2016

D.S. 1822

Exclusively for AEP approved parties, not to be copied nor distributed without written approval.

Appendix 4 – Equipment Location

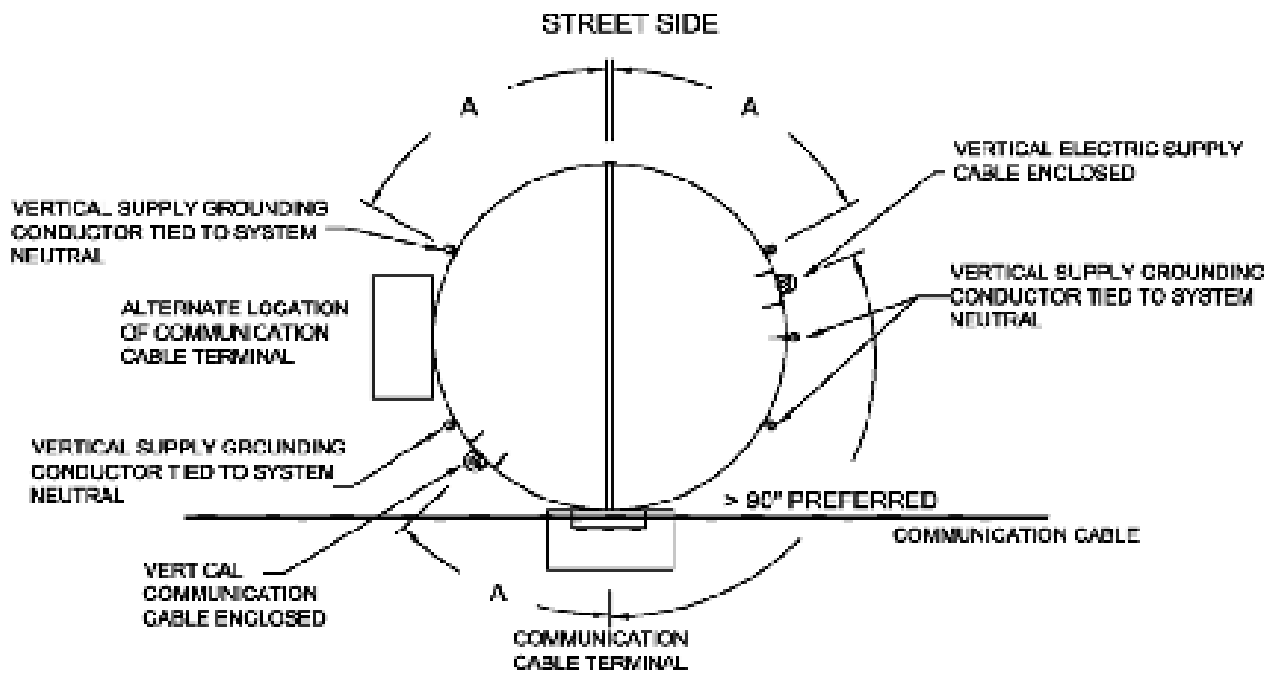

A. 45° WHERE PRACTICAL BUT NEVER CLOSER THAN 2" FROM THE NEAREST METAL PART OF AN ADJACENT UTILITY.

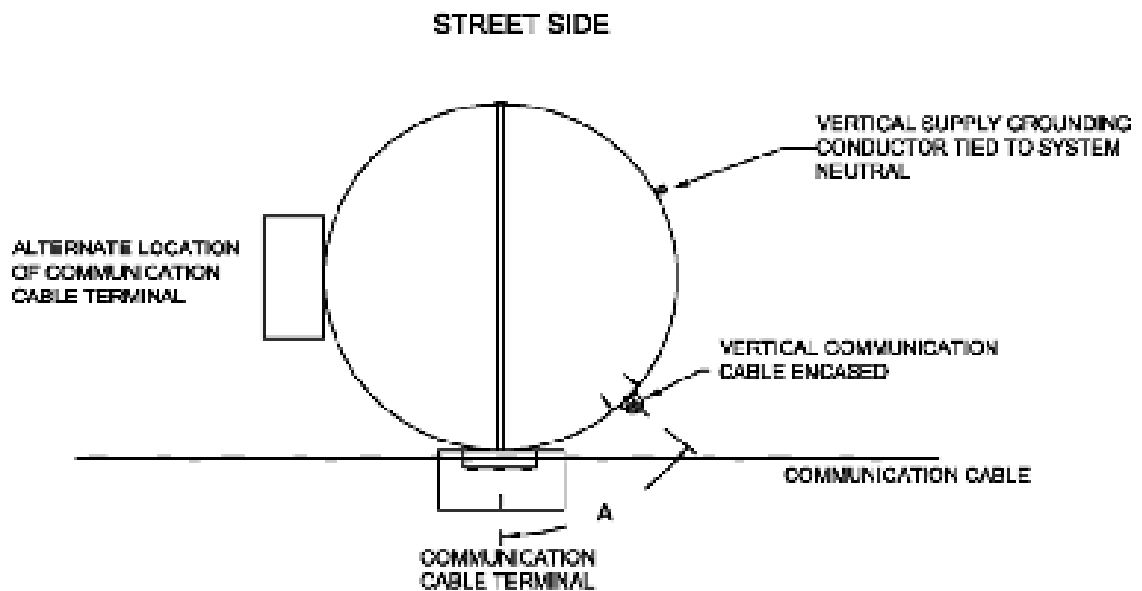

A. 45° WHERE PRACTICAL BUT NEVER CLOSER THAN 2" FROM THE NEAREST METAL PART OF AN ADJACENT UTILITY.

Appendix 5 – Climbing Space

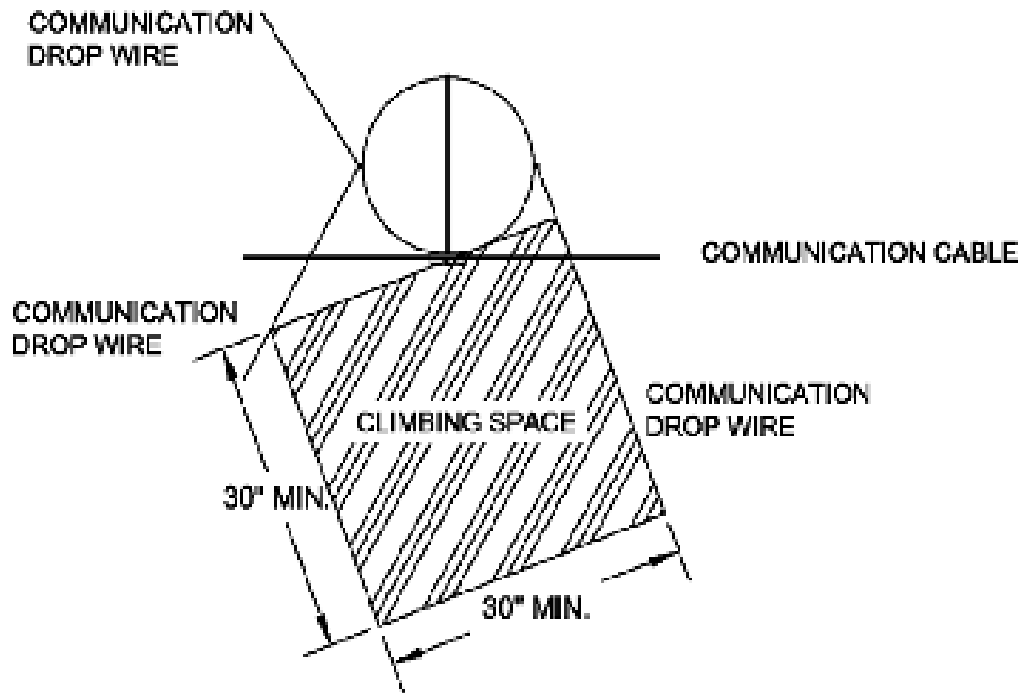
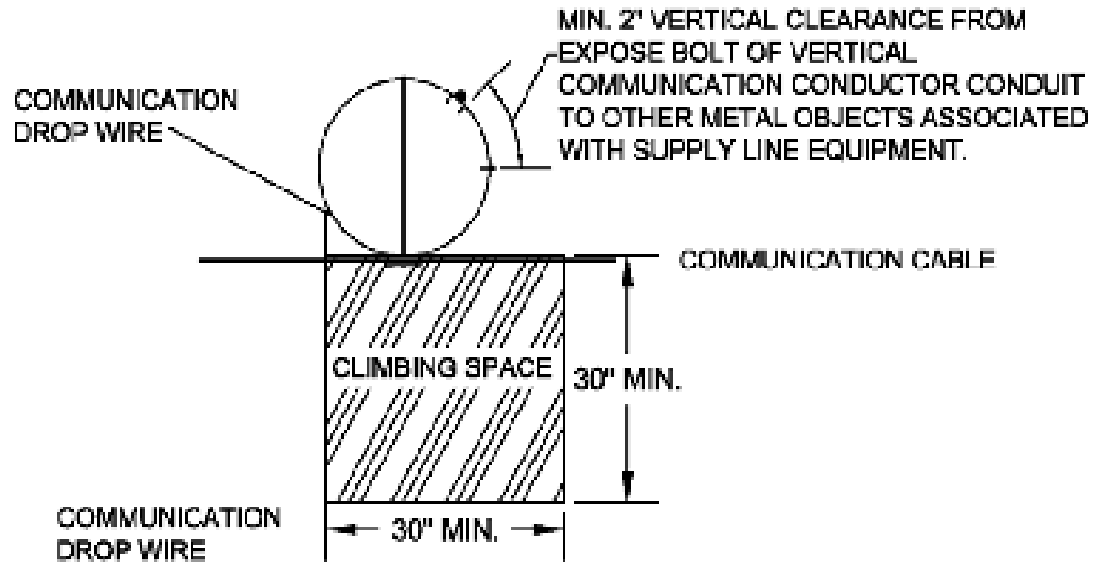

Appendix 6 – Temporary Sign/Banner

AMERICAN ELECTRIC POWER COMPANY

NOTES

1. ALL TYPES OF BANNERS OR SIGNS SHALL BE BLANK SURFACE. ATTACHMENTS FOR BANNERS OVERHEADS OR OVERHEADS ATTACHED TO POLE.
2. NO THROUGH HOLES, BRACKETS, WELLS, TUBES, SCREWS TO BE USED. TACKS, POSTERS OR SIGNS ALLOWED TO REMAIN ATTACHED TO POLE BY WIRE COMPANY'S APPROVAL. POLES TO BE FREE FROM CLIMBING HAZARDS CREATED BY TEMPORARY ATTACHMENTS, INCLUDING WELLS OR HOLES.
3. A MINIMUM CLEARANCE OF 10 FEET ABOVE THE AREAS SUBJECTED ONLY TO PEDESTRIAN OR RESTRICTED TRAFFIC.
4. PRIOR TO ATTACHING THESE BANNERS/TACKS, AN AGREEMENT PREPARABLE BY UTILITIES OR A JOINTLY DEVELOPED AGREEMENT SHALL BE SIGNED BY BOTH THE LICENSEE AND THE OVERHEADS. THE AGREEMENT MUST COVER MINIMUM CLEARANCE TO BE MAINTAINED, DIST. ETC.
5. WITH JOINTLY APPROVAL, ALL PERMITS THE ATTACHMENTS OF THESE BANNERS/TACKS TO BE MAINTAINED IN THE FOLLOWING:
 - a. APPROPRIATE WORKER SAFETY.
 - b. PROTECTIVE CAPABILITY OF SERVICE.
 - c. CAUSE DAMAGE TO THE POLE.
6. THE BANNERS/TACKS MUST BE MADE OF CLOTH OR PAINT MATERIAL WITH NO HAZARDOUS MATERIALS.
7. THE BANNERS/TACKS MUST BE MADE OF CLOTH OR PAINT MATERIAL WITH NO HAZARDOUS MATERIALS. THE BANNERS/TACKS MUST BE MADE OF CLOTH OR PAINT MATERIAL WITH NO HAZARDOUS MATERIALS. THE BANNERS/TACKS MUST BE MADE OF CLOTH OR PAINT MATERIAL WITH NO HAZARDOUS MATERIALS.
8. THE BANNERS/TACKS MUST BE MADE OF CLOTH OR PAINT MATERIAL WITH NO HAZARDOUS MATERIALS.
9. THE BANNERS/TACKS MUST BE MADE OF CLOTH OR PAINT MATERIAL WITH NO HAZARDOUS MATERIALS.
10. THE BANNERS/TACKS MUST BE MADE OF CLOTH OR PAINT MATERIAL WITH NO HAZARDOUS MATERIALS.
11. THE BANNERS/TACKS MUST BE MADE OF CLOTH OR PAINT MATERIAL WITH NO HAZARDOUS MATERIALS.
12. CLEARANCES:
 - a. THE CLEARANCE OF FLAG OR BANNER SIGN ON THE OVERHEADS SHALL BE MAINTAINED WITH THE OVERHEADS. THE CLEARANCE SHALL BE MAINTAINED BY QUALIFIED PERSON.
 - b. THE CLEARANCE OF BANNER SIGN ON THE OVERHEADS SHALL BE MAINTAINED WITH THE OVERHEADS. THE CLEARANCE SHALL BE MAINTAINED BY QUALIFIED PERSON.
 - c. THE CLEARANCE OF BANNER SIGN ON THE OVERHEADS SHALL BE MAINTAINED WITH THE OVERHEADS. THE CLEARANCE SHALL BE MAINTAINED BY QUALIFIED PERSON.
 - d. THE CLEARANCE OF BANNER SIGN ON THE OVERHEADS SHALL BE MAINTAINED WITH THE OVERHEADS. THE CLEARANCE SHALL BE MAINTAINED BY QUALIFIED PERSON.
13. OTHER TYPES OF ATTACHMENTS: FLAGPOLES, SIGNS, ETC. SHALL BE APPROVED BY THE LICENSEE AND THE OVERHEADS. THE CLEARANCE SHALL BE MAINTAINED BY QUALIFIED PERSON.

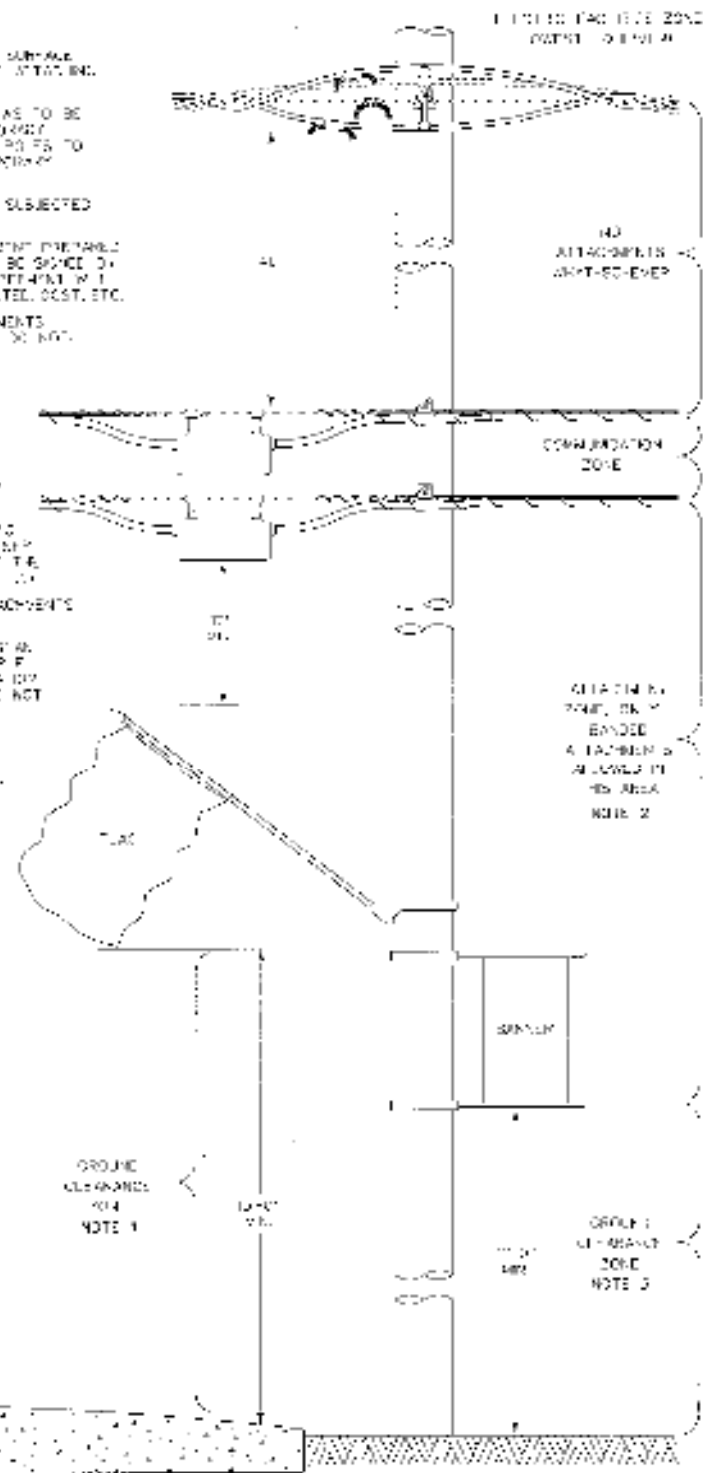

TEMPORARY SIGN, BANNER, POSTER ATTACHMENTS TO ELECTRIC SUPPLY POLES OVERHEADS - ALL VOLTAGES

Appendix 7 – Clearance for Lighting Facilities

AMERICAN ELECTRIC POWER COMPANY DISTRIBUTION STANDARDS

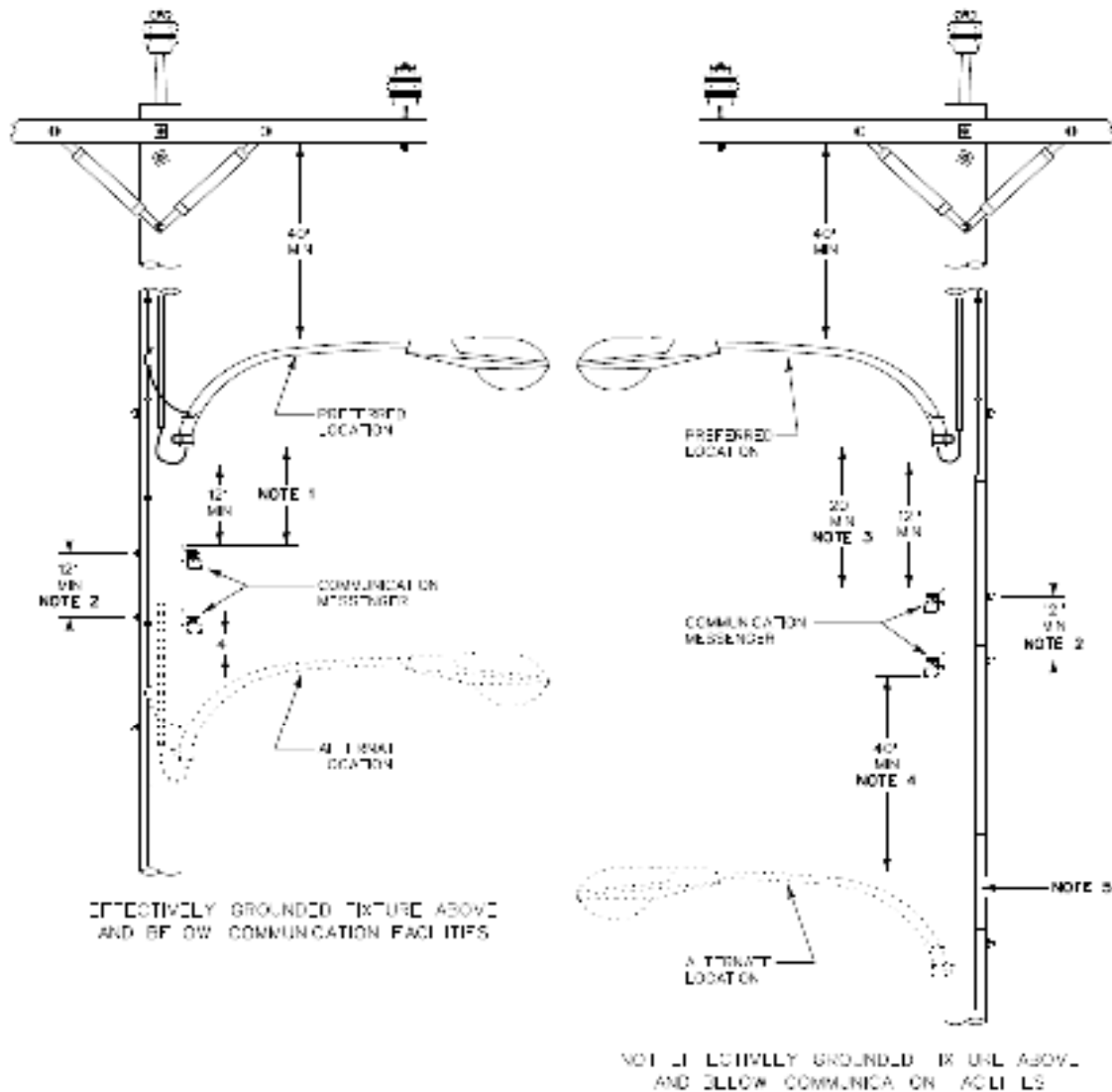

NOTES

- CLEARANCE TO A GROUNDING FEATURE MAY BE REDUCED TO 4' NOTCHES PROVIDED A 3' NOTCH CLEARANCE IS MAINTAINED FROM THE NOTCH TO THE FACILITY. ALL FACILITIES ARE REQUIRED TO BE COVERED WITH A NON-FLAMMABLE COVERING, REFER TO RULE 2000, IRECEC.
- THE MINIMUM SPACING BETWEEN TELECOMMUNICATION POLE ATTACHMENTS OR CONDUIT JOINTS IS 18 INCHES.
- THIS DIMENSION MAY BE REDUCED TO 10 INCHES FOR OTHER SPAN WIRES OR METAL PARTS OF BRACKETS AT POINTS 40' NOTCHES OR MORE FROM THE STRUCTURE SURFACE.
- THIS DIMENSION MAY BE REDUCED TO 20' NOTCHES FOR LUMINAIRES OPERATING AT LESS THAN 150 VOLTS TO GROUND.
- WHEN UNGROUNDING EXISTING OR NEW BELOW GROUND COMMUNICATION FACILITIES, HOLDING SHALL BE INSTALLED OVER GROUND WIRES EXTENDING FROM 40' NOTCHES ABOVE THE COMMUNICATION FACILITIES TO 72 INCHES BELOW THE SUPPORT FACILITIES.

CLEARANCES FOR LIGHTING FACILITIES

DECEMBER 10, 2009

ALL VOL. 9025

D.S. 702

Appendix 8 – Clearances for Telecommunications Equipment

AMERICAN ELECTRIC POWER COMPANY DISTRIBUTION STANDARDS

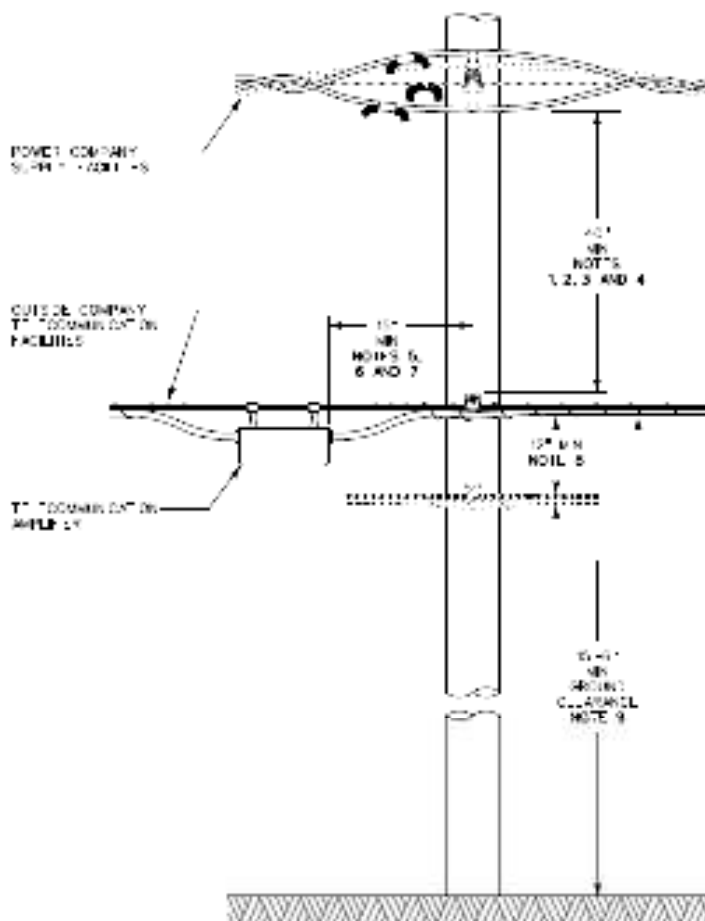

NOTES:

1. TELECOMMUNICATION EQUIPMENT OTHER THAN COMMUNICATION CABLE SHALL NOT BE INSTALLED ON CAPACITOR, TRANSFORMER, REGULATOR, RECLOSER, SECTIONALIZER, OR PRIMARY/SECONDARY FEEDER POLES.
2. CLEARANCES SHOWN ARE FOR SUPPLY CONDUCTORS RATED 8.7 KV AND BELOW (BASE TO GROUND). CLEARANCES INCREASE WHEN SUPPLY CONDUCTORS ARE RATED GREATER THAN 8.7 KV. REFER TO NATIONAL ELECTRIC SAFETY CODE (NEC) TABLE 235-5. FOR SAG CLEARANCE REQUIREMENTS, REFER TO RULE 235C(2)(III).
3. PER NEC TABLE 235-5, NOTE 5 WHERE THE COMMUNICATION MESSENGER IS BONDED TO THE GROUNDING CONDUCTOR WITH A MINIMUM OF EIGHT (8) CONNECTIONS IN EACH MILE, THIS DIMENSION MAY BE REDUCED TO 30 INCHES.
4. FOR CLEARANCES FROM STREET LIGHTING BRACKETS, REFER TO D.S. 702.
5. SUPPLY SERVICE CONDUCTOR ATTACHED DIRECTLY TO THE POLE SHALL MAINTAIN A MINIMUM OF 40 INCHES CLEARANCE TO METAL OBJECTS OF TELECOMMUNICATION EQUIPMENT, TABLE 238-1 OF NEC.
6. ATTACHMENTS OF ALL COMMUNICATION TYPE FACILITIES TO BE ON THE SAME SIDE OF POLE. CATV SERVICES TO BE TAKEN OFF CATV CABLE AND MESSENGER, AND NOT AT POLE. PROVIDE 30 INCHES HORIZONTAL CLIMBING SPACE THROUGH ATTACHED EQUIPMENT.
7. TELECOMMUNICATION ATTACHMENTS AND ASSOCIATED EQUIPMENT, SUCH AS AMPLIFIERS, SHALL BE INSTALLED IN A MANNER SATISFACTORY AS TO NOT TO INTERFERE WITH THE PRESENT OR ANY FUTURE USE WHICH COMPANY MAY DESIRE TO MAKE OF ITS POLES. NO STANDBY POWER SUPPLY EQUIPMENT SHALL BE PERMITTED TO BE ATTACHED TO COMPANY POLES.
8. THE MINIMUM SPACING BETWEEN TELECOMMUNICATION POLE ATTACHMENTS FOR CONSTRUCTION/MAINTENANCE.
9. DIMENSION SHOWN IS A MINIMUM SAG CLEARANCE ABOVE GROUND FOR INSULATED TELECOMMUNICATION CONDUCTORS AND CABLE UNDER NEG ZONE CONDITIONS. POLE ATTACHMENT LOCATION MAY BE AT A DIFFERENT HEIGHT. REFER TO RULE 232 AND TABLE 332-4 OF THE NEC FOR REQUIREMENTS TO DETERMINE THE PROPER POLE ATTACHMENT HEIGHT.

CLEARANCES FOR JOINT USE TELECOMMUNICATION EQUIPMENT AND CABLES

SEPTEMBER 10, 2010
(PREVIOUSLY D.S. 701-4)

4 THRU 35 KV

D.S. 1821

Exclusively for AEP approved parties, not to be copied nor distributed without written approval.

Appendix 9 – Guy Wires

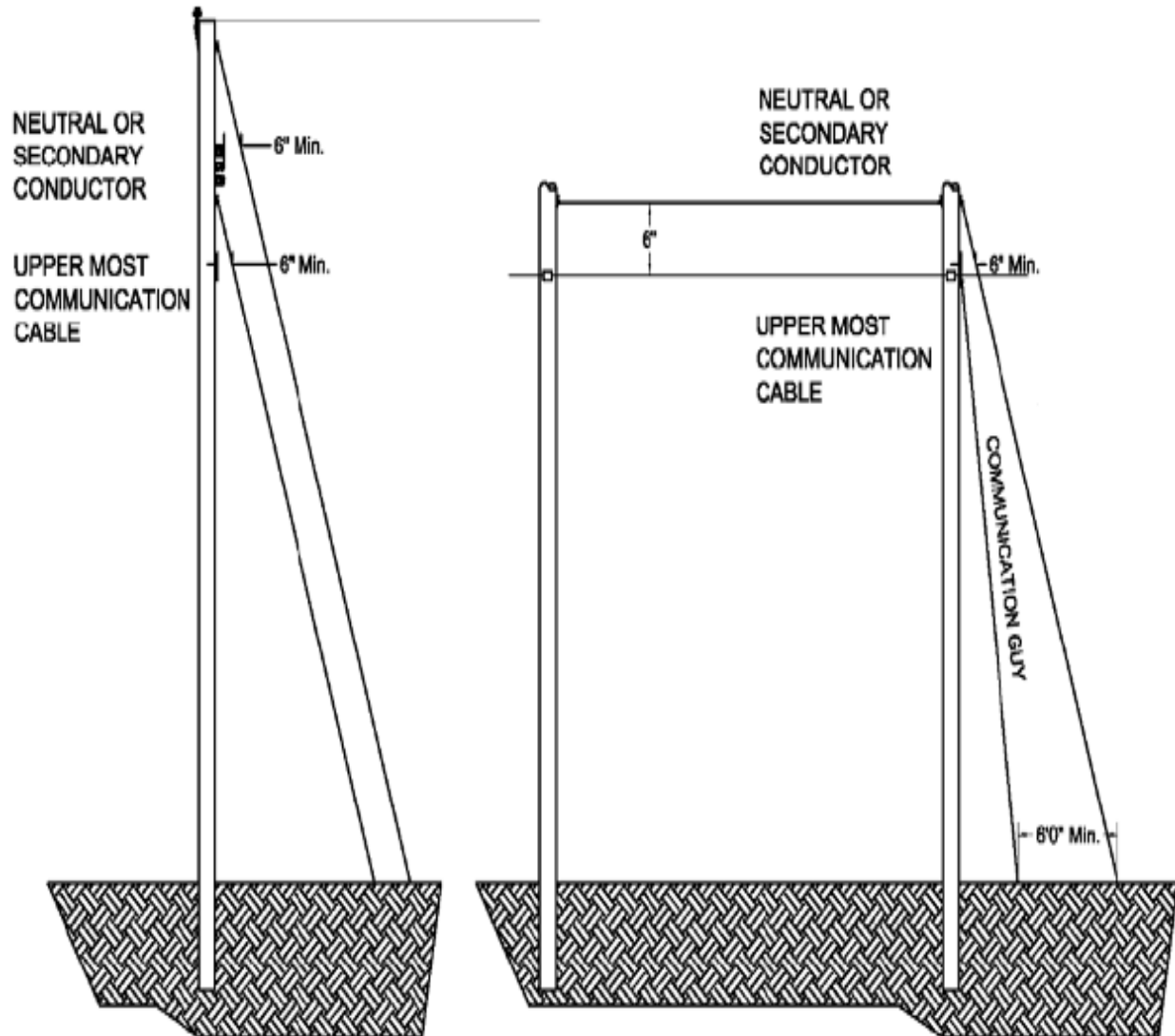

1. 6" MIN. REQUIRED IN ANY DIRECTION FROM THE HIGHEST COMMUNICATION LINE TO POWER GUYS

2. GUYS THAT PASS WITHIN 12" OF COMMUNICATION CABLE SHALL BE GROUNDED OR INSULATED WITH GUY INSULATORS TO A POINT BELOW THE LOWEST CONDUCTOR.

3. COMMUNICATION GUY ANCHORS SHALL BE A MINIMUM OF 6' FROM POWER GUY ANCHORS

Appendix 10 – Parallel Span Guys

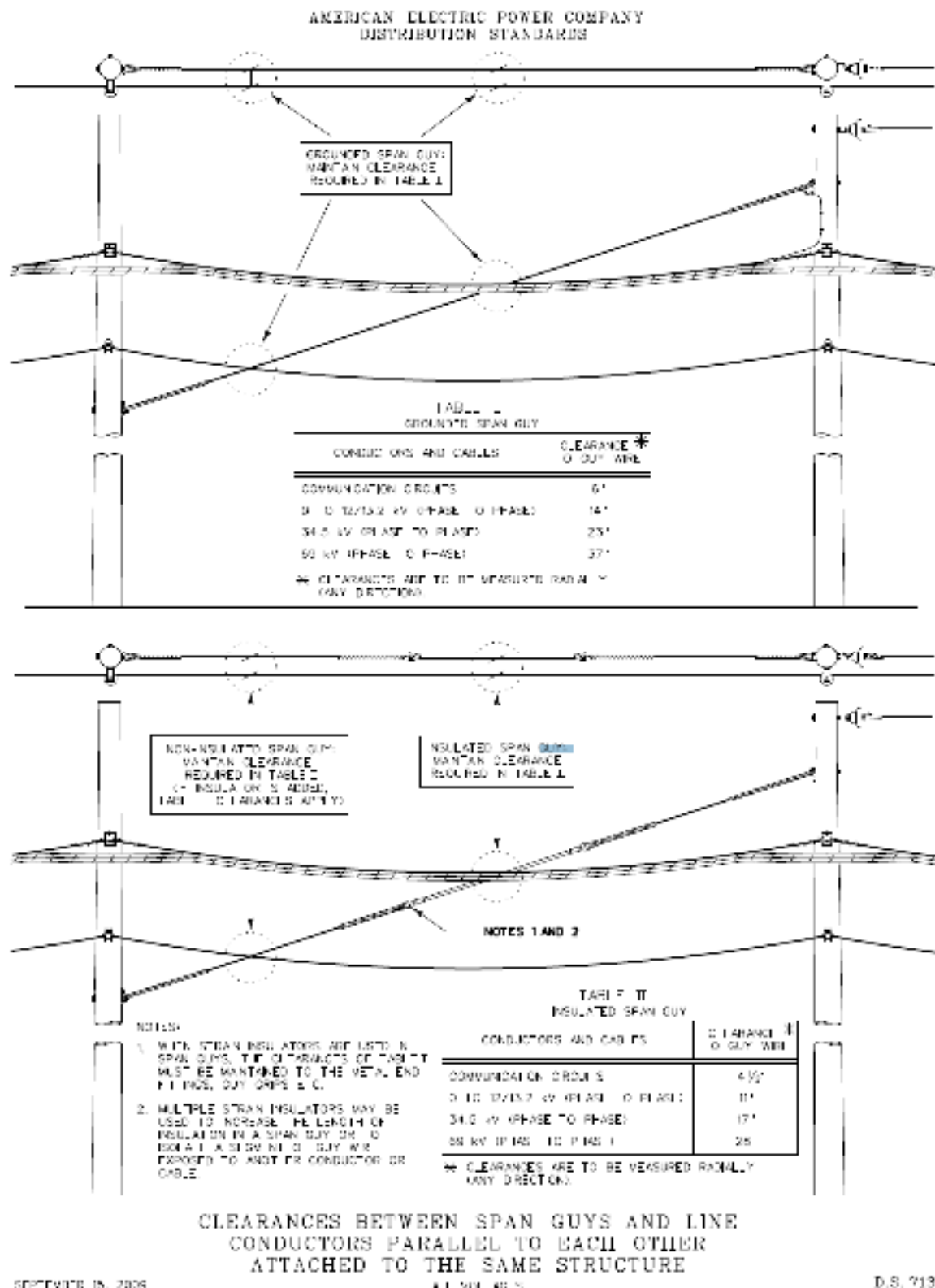

Appendix 11 – Transverse Span Guys

AMERICAN ELECTRIC POWER COMPANY
 DISTRIBUTION STANDARDS

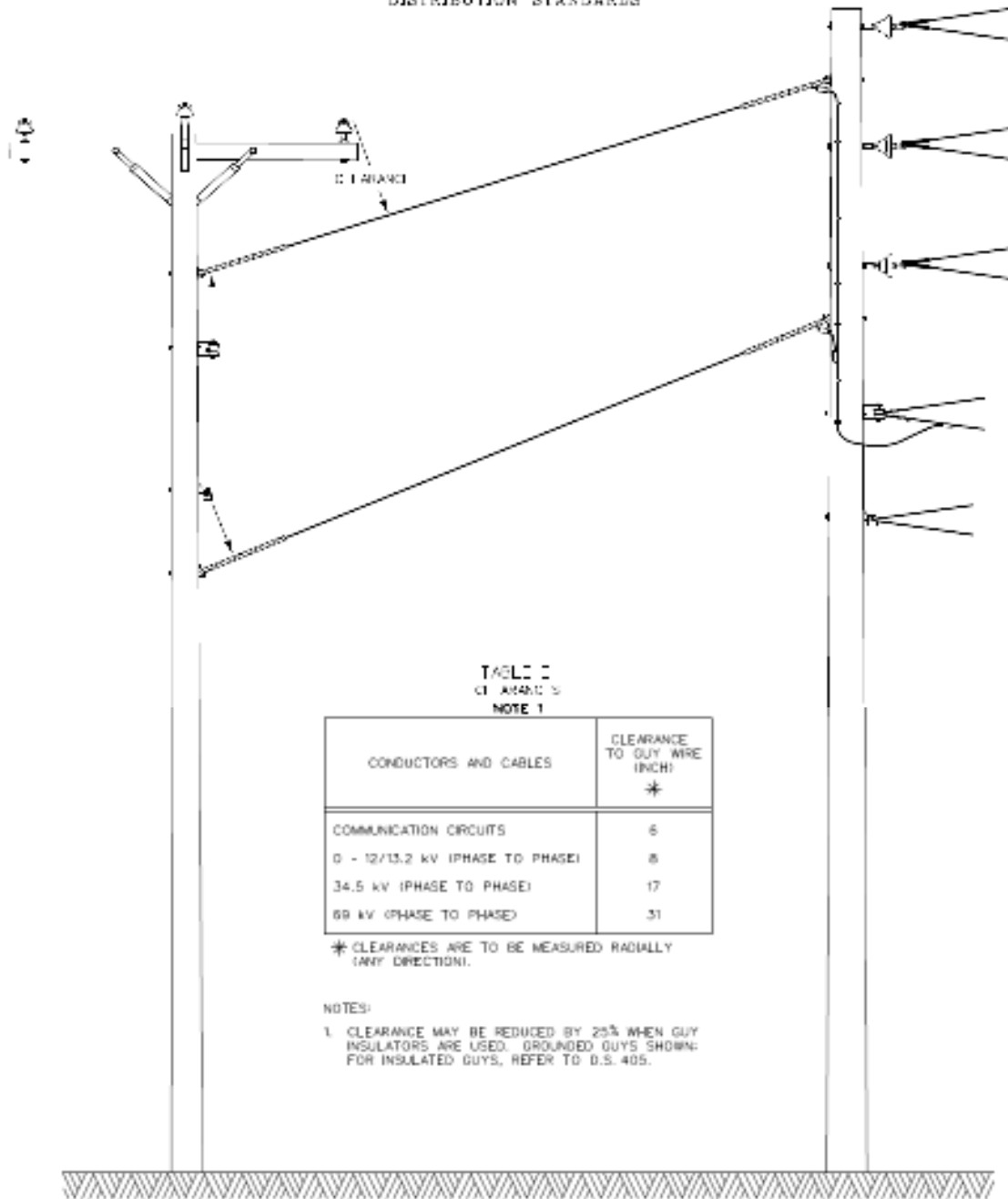

CLEARANCES BETWEEN SPAN GUYS AND LINE
 CONDUCTORS TRANSVERSE TO EACH OTHER
 ATTACHED TO SAME STRUCTURES

SEPTEMBER 15, 2009

ALL VOLTAGES

D.S. 714

Exclusively for AEP approved parties, not to be copied nor distributed without written approval.

Appendix 12 – Pole Numbering and Tagging

AMERICAN ELECTRIC POWER COMPANY DISTRIBUTION STANDARDS

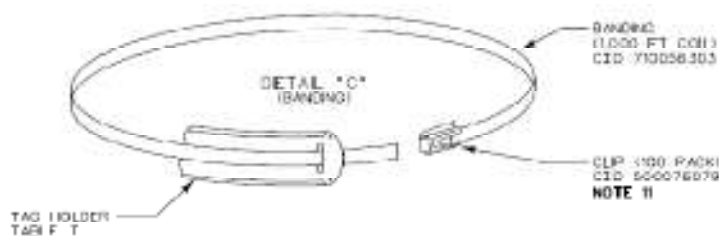
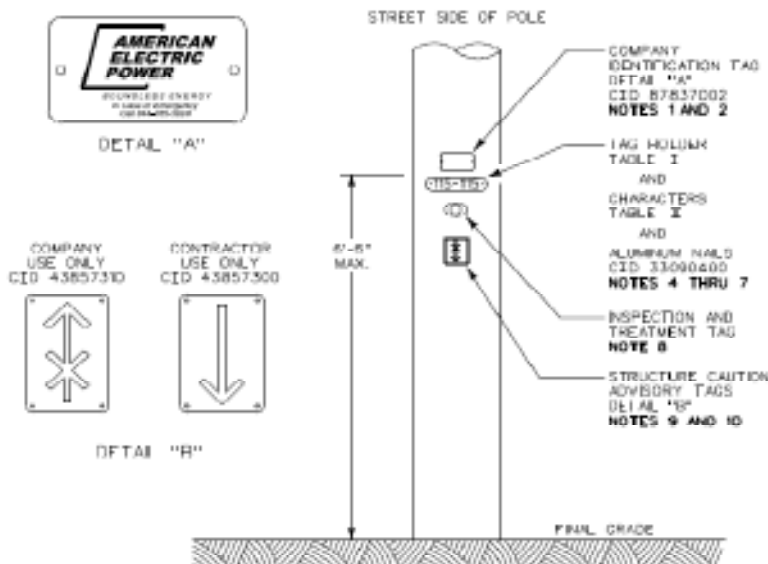

NOTES:

1. COMPANY IDENTIFICATION TAGS SHALL ONLY BE INSTALLED ON COMPANY OWNED POLES.
2. ONLY POLE NUMBERS SHALL BE USED TO IDENTIFY AEP CONTACTS ON FOREIGN OWNED POLES. AEP COMPANY IDENTIFICATION TAG SHALL NOT BE USED TO IDENTIFY CONTACT ON FOREIGN POLES.
3. TAG HOLDERS ACCOMMODATE ONE CHARACTER PER INCH.
4. CRIMP BOTH ENDS OF ALUMINUM HOLDER AFTER CHARACTERS ARE INSTALLED.
5. IN AREAS WITH GREY NUMBERS, INSTALL GREY TAG (CID 43857700 (OHNS) OR 43857714 (TEXAS)).
6. TAGS SHALL BE SECURED TO STEEL POLES BY BANDING (DETAIL C) OR SEALING COMPOUND TAPE (CID 93094000).
7. TAGS SHALL BE SECURED TO DUCTILE IRON OR COMPOSITE POLES WITH SELF-LAPPING SCREWS (CID 265060).
8. STANDING WOOD POLES THAT ARE INSPECTED OR TREATED SHALL BE MARKED TO INDICATE DATE AND TYPE OF TREATMENT.
9. POLE ADVISORY TAGS SHALL ONLY BE INSTALLED BY CONTRACTORS OR COMPANY PERSONNEL WHEN THE CONDITION OF THE FACILITIES WARRANTS FOLLOW-UP EVALUATION AND/OR REPAIR.
10. UPON INSTALLATION, THE ARROW SHALL POINT IN THE DIRECTION OF THE HAZARD.
11. INSERT FIRST END INTO CLIP AND BEND BACK APPROXIMATELY 1/2" (AS SHOWN). INSERT SECOND END AND PULL BANDING UNTIL TIGHT. THE CLIP IS SELF LOCKING AND NO FURTHER ACTION IS REQUIRED.





TABLE I

CID NUMBER	MAX. DFR. LENGTH (INCHES) NOTE 3
87835980	8 1/2
87835985	9 1/2
87835990	10 1/2
87836200	12 1/2

TABLE II

CID NUMBER	CHARACTER
87447005	0
87447105	1
87447205	2
87447305	3
87447405	4
87447505	5
87447605	6
87447705	7
87447805	8
87447905	9
87158104	DASH
87156404	BLANK
87432605	A
87432705	B
87432805	C
87432905	D
87433005	E
87433105	F
87433205	G
87433305	H
87433405	T
87433505	J
87433605	K
87433705	L
87433805	M
87433905	N
87434005	O
87434105	P
87434205	Q
87434305	R
87434405	S
87434505	T
87434605	U
87434705	V
87434805	W
87434905	X
87435105	Y
87435205	Z

Appendix 13 – Examples of Advisory Tags

<p>SAFETY FIRST!!</p> <p><u>DO NOT CLIMB REJECTED POLES!</u></p>	<p>REJECTED POLE TAGGING:</p>
	<p>Reject pole planned for reinforcement</p>  <p>Yellow tag</p>
	<p>Reject pole planned for replacement</p>  <p>White tag</p>
	<p><u>Priority reject</u> pole planned for replacement</p> <p>red arrow (points toward hazard):</p>  <p>Contractor</p> <p>OR</p> <p>2 white tags:</p>  <p>OR</p> <p>Red arrow with X (points toward hazard):</p>  <p>Company</p>